

644-3-PGE

SECTION AA

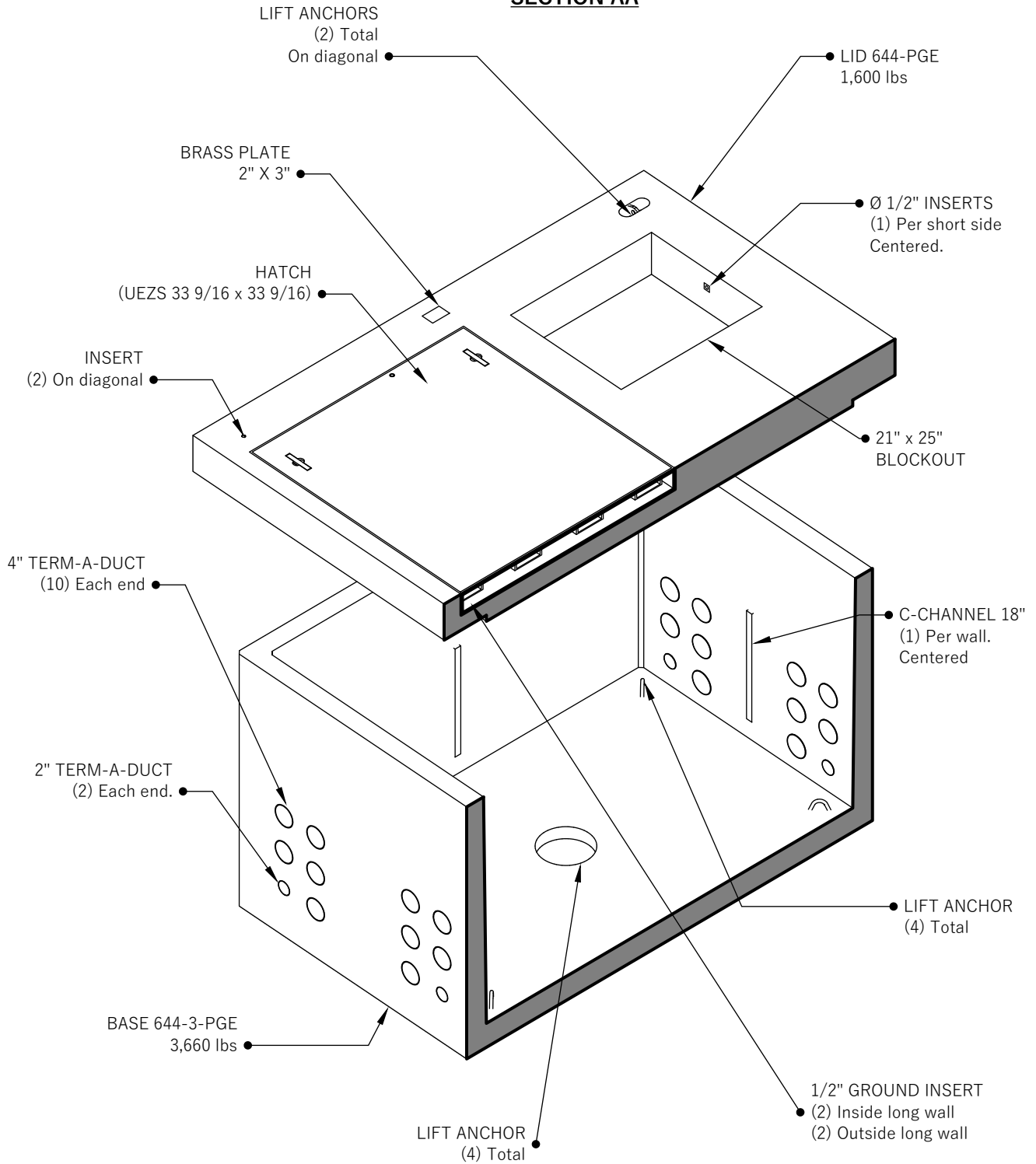

644-3-PGE

541-923-3272
1111 NE 11TH ST.
REDMOND, OR
97756

644-3-PGE

PLAN VIEW

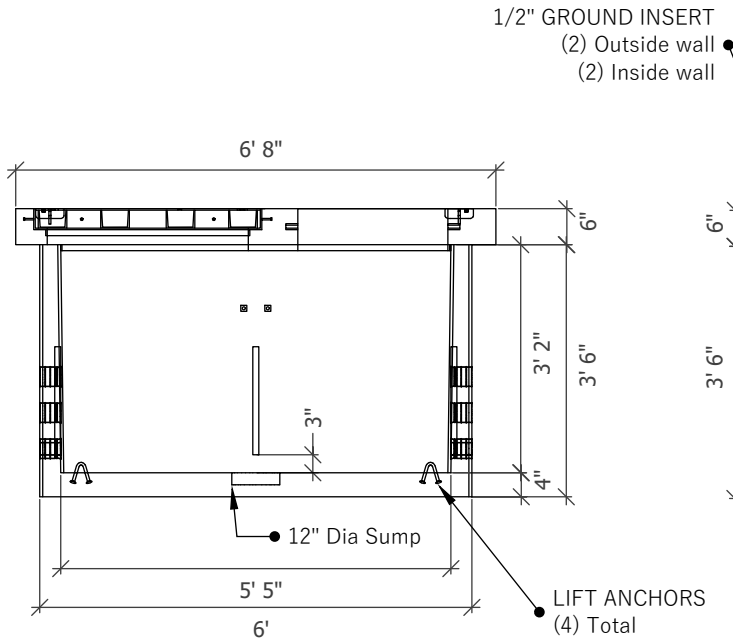
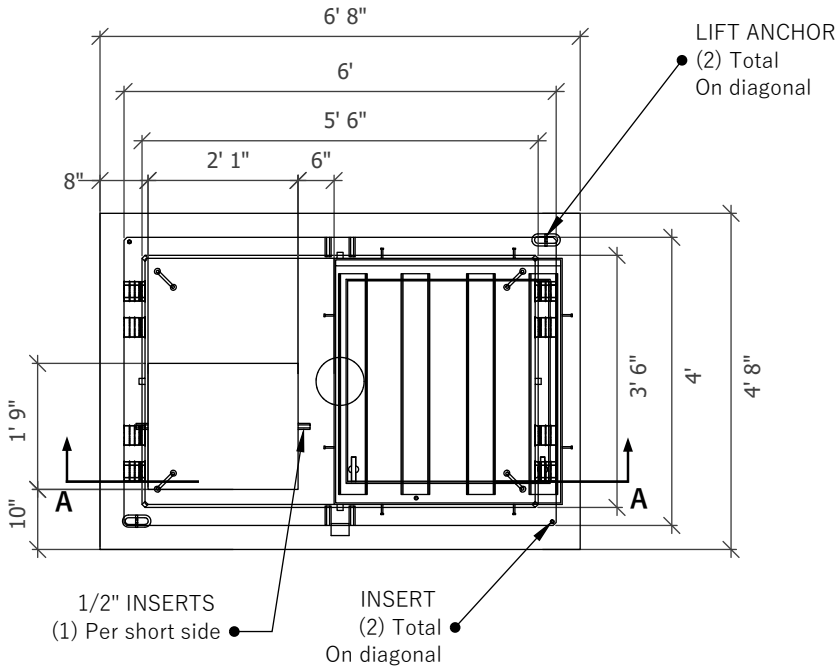

SIDE VIEW

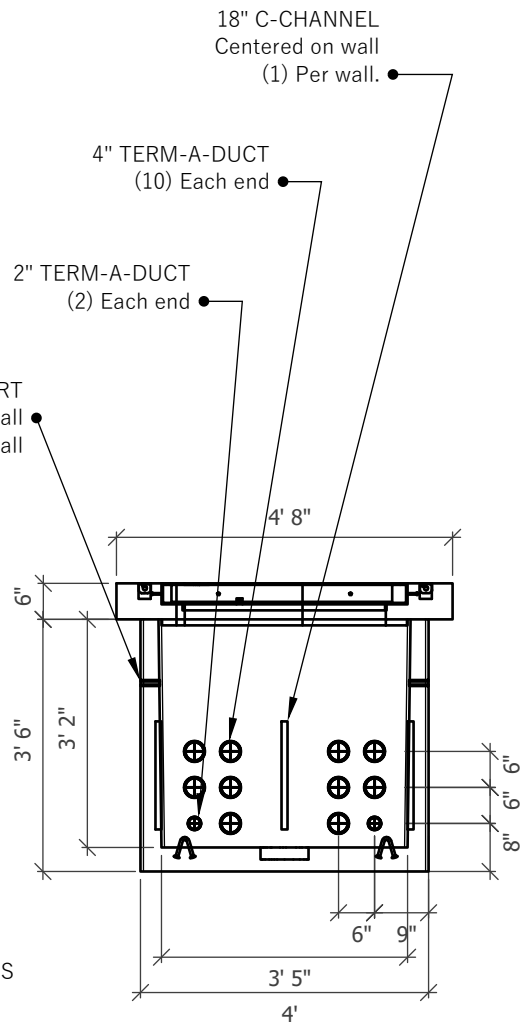

END VIEW



644-3-PGE

541-923-3272
1111 NE 11TH ST.
REDMOND, OR
97756

SIDE VIEW

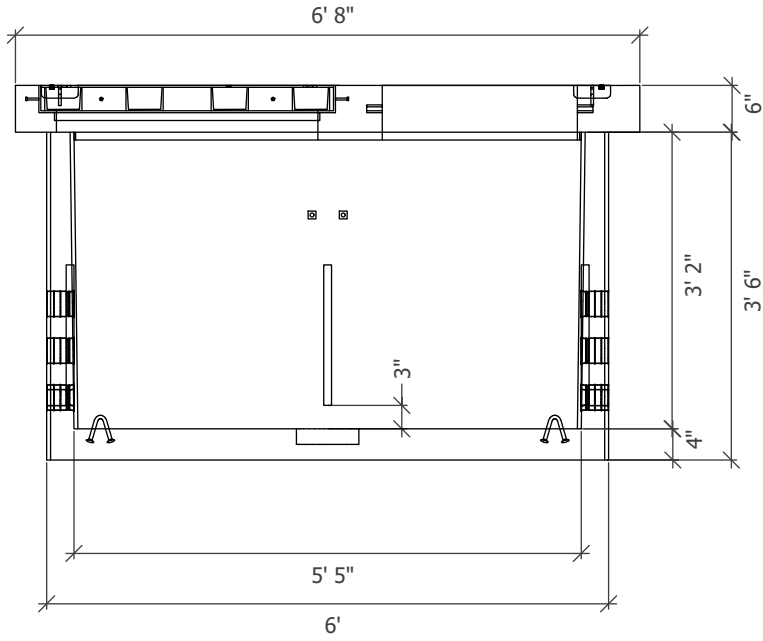

END VIEW

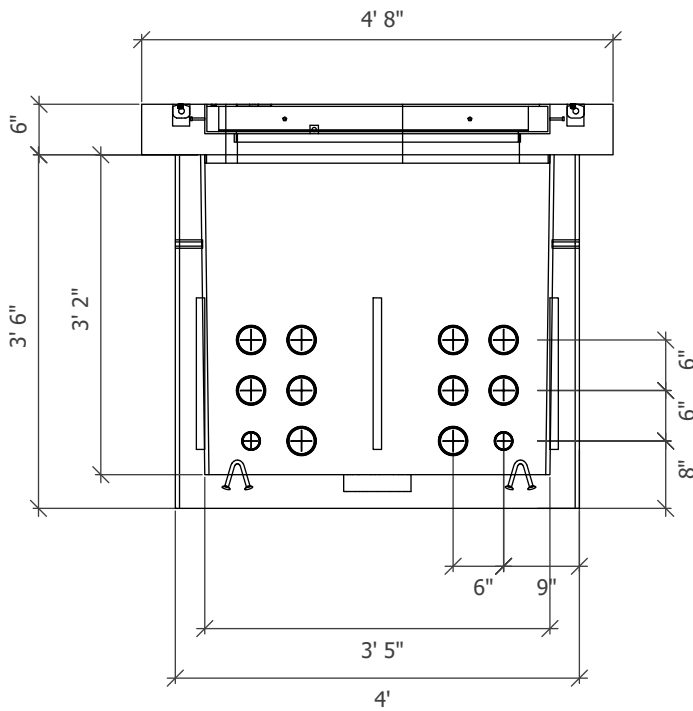

644-3-PGE

QUALITY CONTROL CHECKLIST	
INSPECTOR	DATE
PRE-POUR	
ITEM	INITIALS
Form Condition	
Form Cleanliness	
Design Width	
Design Length	
Design Height	
Form Release	
Blockouts	
Reinforcing Steel	
Termaduct Placement	
Lift Anchor Placement	
Top Finish	
Ground Insert Placement	
Concrete Sample Poured	
POST-POUR	
Mark Name/ Number	
Surface Texture	
Cracks or Spalls	
Exposed Reinforcement	
Lift Devices	
Blockouts	
Strut Channel	
Termaducts	
Ground Inserts	
Notes:	



644-3-PGE

541-923-3272
 1111 NE 11TH ST.
 REDMOND, OR
 97756

644-3-PGE

SECTION AA

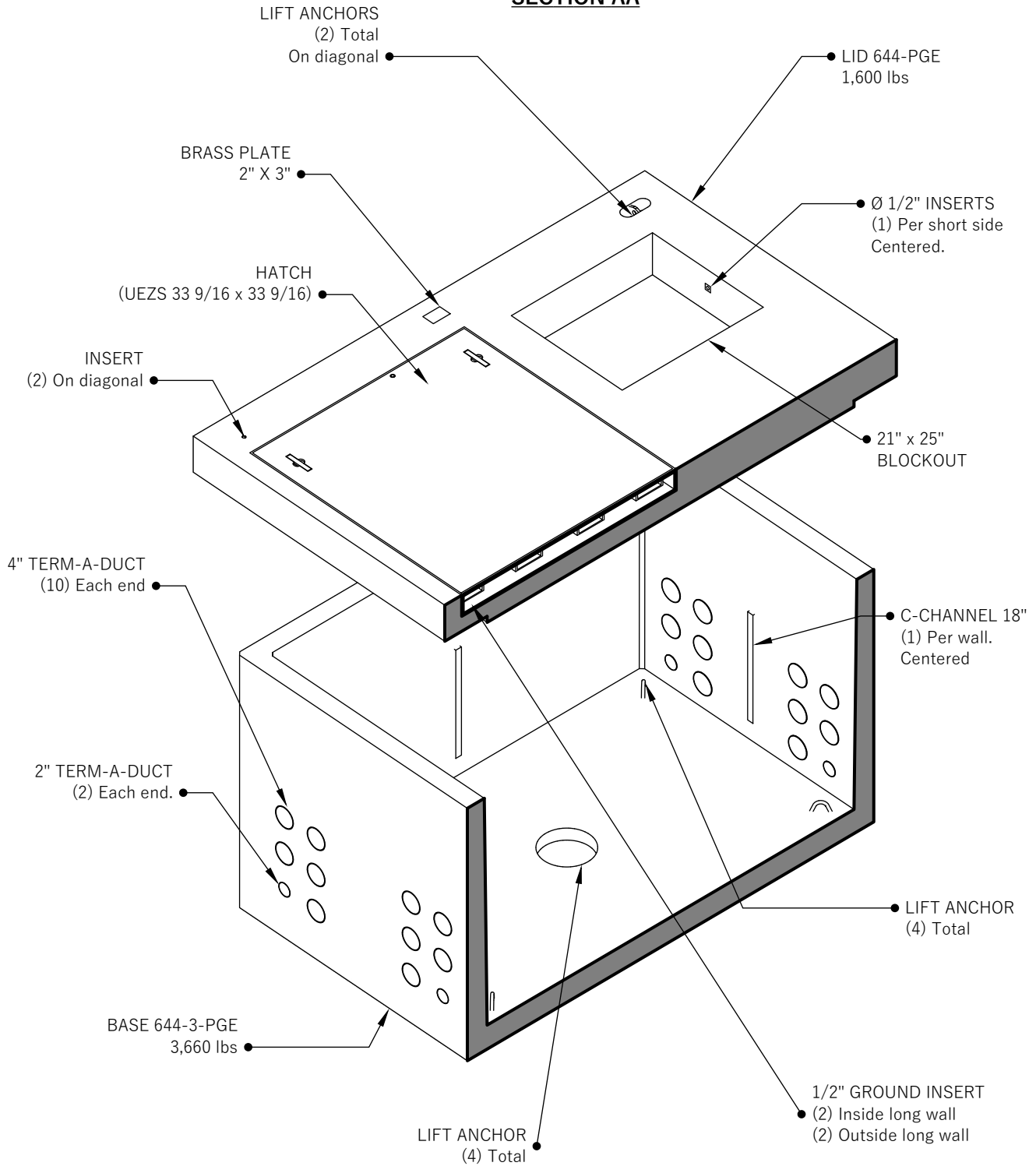

Customer:
Project:
Product:



644-3-PGE

541-923-3272
1111 NE 11TH ST.
REDMOND, OR
97756